

Man Safe 6018 Configuration #2

Features & Specifications:

Interior Dimensions	60"H x 18"W x 16.5"D
Exterior Dimensions	61"H x 19"W x 22"D
Interior Drawer Dimensions	12 3/4"W x 13"D
Capacity in Cubic Ft.	11
Weight	700 LBS
Watch Winders	Thirty-two
Drawer Configuration	One 2" Drawer
.....	One 3" Drawer
.....	One 5" Drawer
Open Space	9" inches

32 Watch Winders

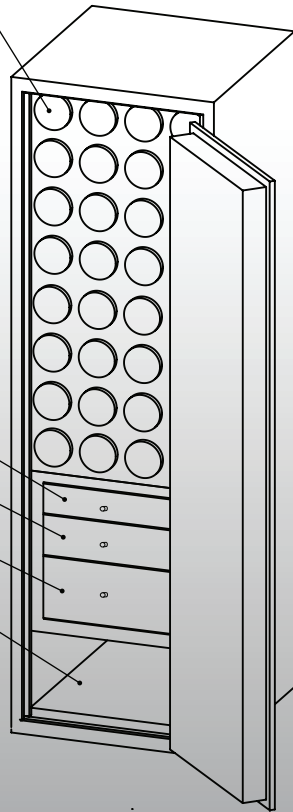

One 2" Drawer

One 3" Drawer

One 5" Drawer

Open Space = 9"

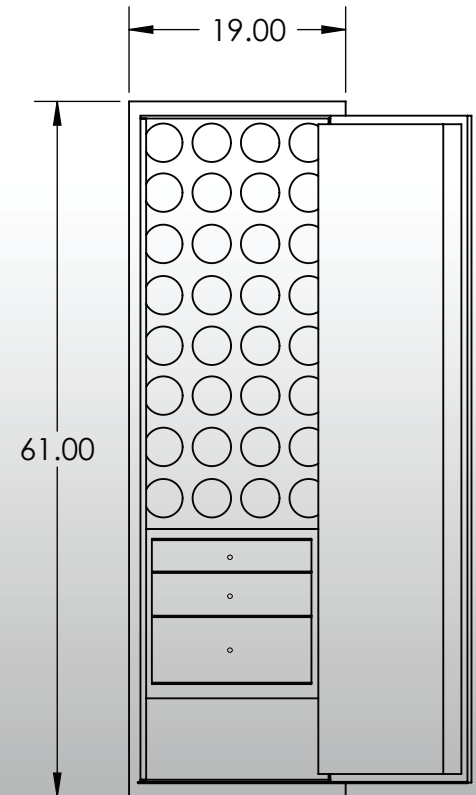
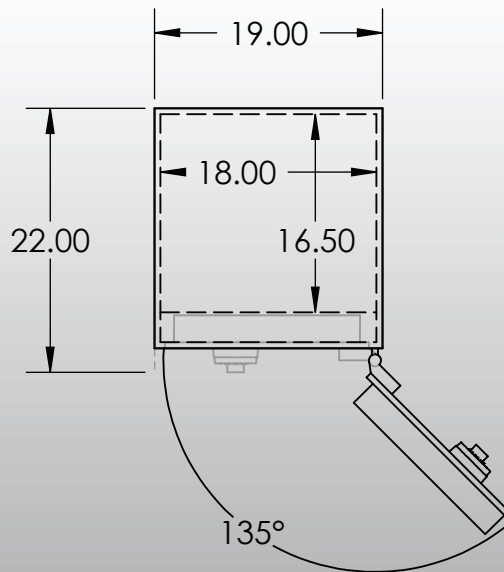

* Please add 1" to all exterior dimensions to allow for installation.

** Standard 120 volt outlet required for operation. Two cords exit at lower back of safe on hinge side to provide power to interior light and watch winders.